

UNITA' OPERATIVA

LUNAR

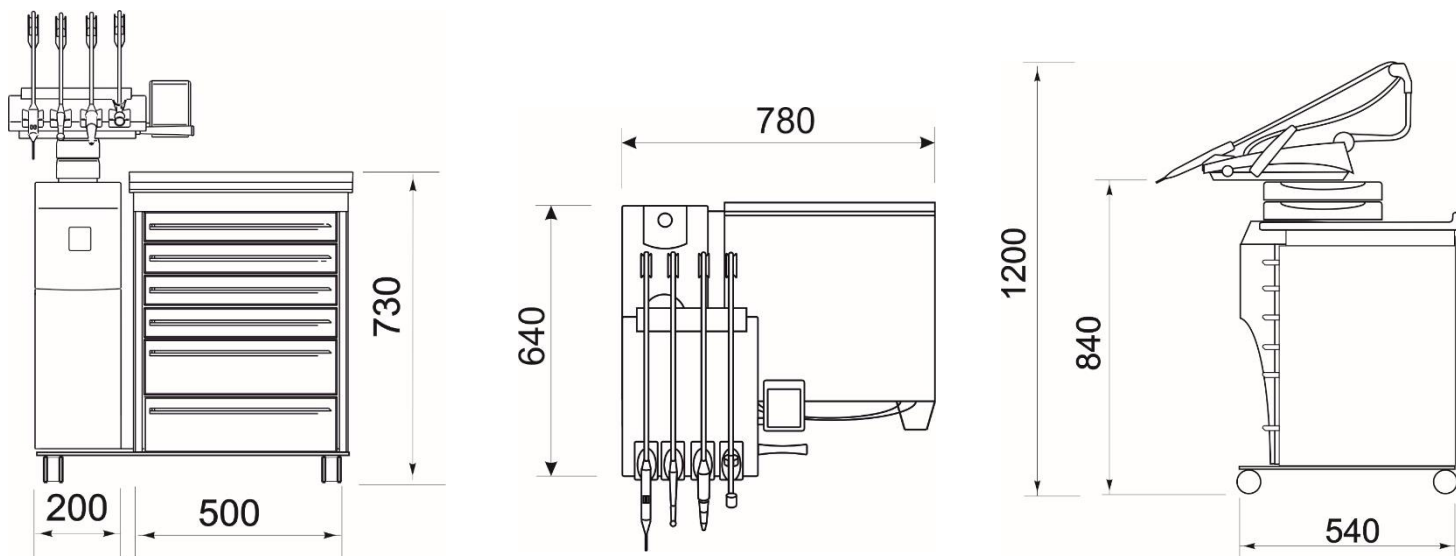

Caratteristiche tecniche:

- Voltaggio operativo: 24 V
- Alimentazione: 230 v/115 v, 250 W
- Aria: 5 bar, 50 l/min
- Peso: 90 Kg

CHEST OF DRAWERS' CONFIGURATION



SENZA MANIGLIE

Cassetti montati su guide «push» che permettono di aprire il cassetto con una leggera pressione sul frontale.



MANIGLIE BIANCHE

Cassetti montati su guide a chiusura assistita e dotati di maniglia in alluminio di nuovo design verniciata in bianco.



MANIGLIE COLORATE

Cassetti montati su guide a chiusura assistita e dotati di maniglia in alluminio di nuovo design verniciata in colore a scelta da selezione Stern Podia.

TIPOLOGIA CASSETTI (T1/T2/T3) E PORTE (T5/T8):

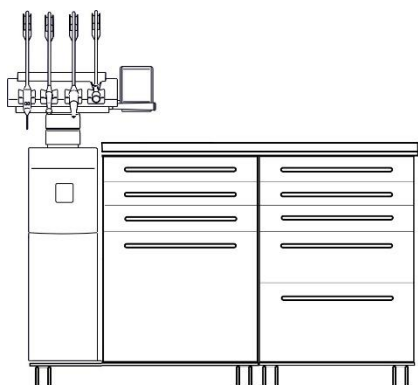
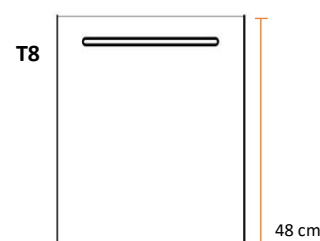
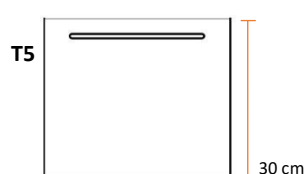
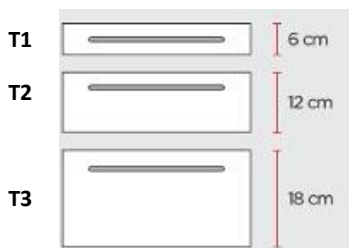



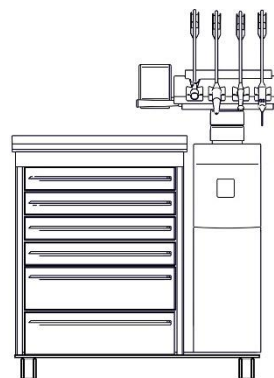







Possibilità di configurare il riunito podologico con una cassettiera supplementare.



Possibilità di ordinare il riunito Lunar in configurazione mancina.

INTERNI CASSETTI

T1	 liscio	 4 scomparti	 portastrumenti	 8 scomparti	 16 scomparti
T2	 2 scomparti	 6 scomparti	 liscio		
T3	 2 scomparti	 6 scomparti	 liscio		

Opzione:
frontale cassetti verniciati in colore a
scelta da selezione Stern Podia.

