

## UNITA' OPERATIVA

# ATLAS

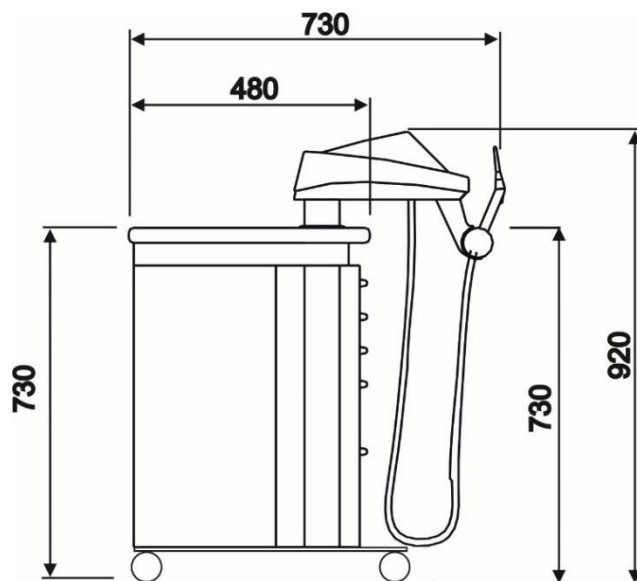
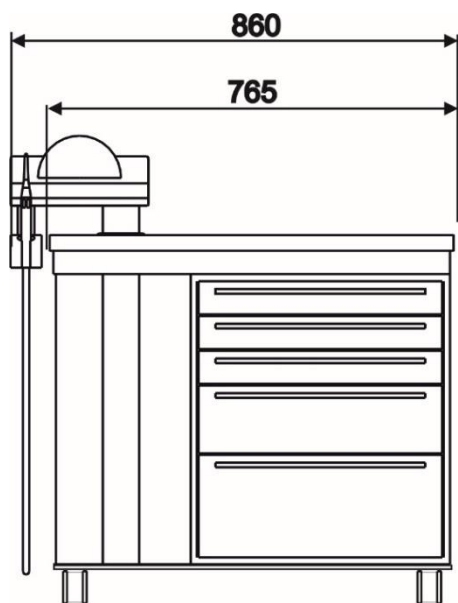

### Caratteristiche tecniche:

- Voltaggio operativo: 24 V
- Alimentazione: 230 v/115 v, 250 W
- Aria: 5 bar, 50 l/min
- Peso: 80 Kg

### CHEST OF DRAWERS' CONFIGURATION



#### SENZA MANIGLIE

Cassetti montati su guide «push» che permettono di aprire il cassetto con una leggera pressione sul frontale.



#### MANIGLIE BIANCHE

Cassetti montati su guide a chiusura assistita e dotati di maniglia in alluminio di nuovo design verniciata in bianco.



#### MANIGLIE COLORATE

Cassetti montati su guide a chiusura assistita e dotati di maniglia in alluminio di nuovo design verniciata in colore a scelta da selezione Stern Podia.

### TIPOLOGIA CASSETTI (T1/T2/T3) E PORTE (T5/T8):

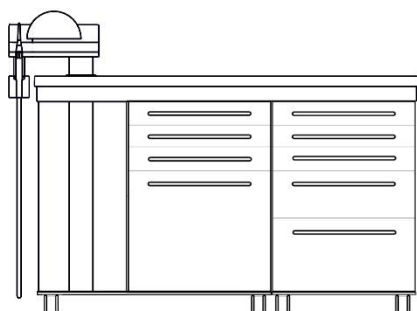
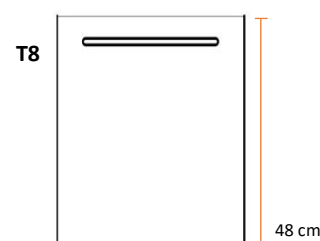
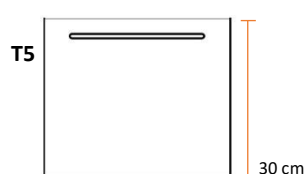



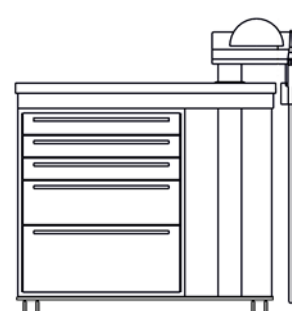







Possibilità di configurare il riunito podologico con una cassetteria supplementare.



Possibilità di ordinare il riunito Atlas in configurazione mancina.

## INTERNI CASSETTI

T1	 liscio	 4 scomparti	 portastrumenti	 8 scomparti	 16 scomparti
T2	 2 scomparti	 6 scomparti	 liscio		
T3	 2 scomparti	 6 scomparti	 liscio		

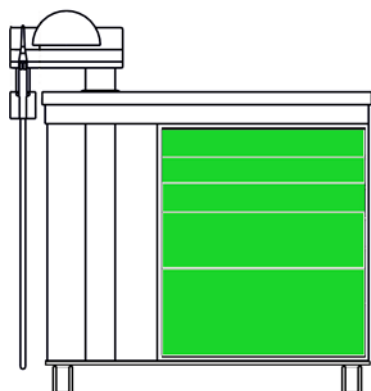

**Opzione:**  
frontale cassetti verniciati in colore a  
scelta da selezione Stern Podia.

